



Concepts

Products

Services

Everything else look obsolete

Designed &
Manufactured by :



Student Desking Solutions

Marketed by :



Note from CEO

Where manufacturing meets empathy, passion and innovation, it becomes Workspace. Started in 2007 from a small area of 1,000 Sq.M. and a bunch of 12 passionate people, today we stand at 20,000 Sq.M. with a workforce of 400 people looking at 30 Million USD in couple of years to come.

We at workspace value the end user, the stake holders' expectations and create products and solutions that are functionally correct, meeting timelines, ergonomically compliant, modular and scalable, acceptable, aesthetically pleasing thereby triggering ownership in the stake holders and can be installed anywhere on the globe.

All this is possible by best in class manufacturing facility which boasts of high-end German / Japanese/ Italian machines that ensure precision to 0.01 mm other than dedicated team of R&D personnel.

Using best on the globe materials from Austria/Germany/USA and the likes help us not only give the wow factor to our product but also ensures meeting global norms and quality standards. Health & Safety of people is a major focus while we create product from raw material.

And yes, a portion of our earnings through you goes into CSR activities thereby creating a better world to live in.

Do join hands

Thanks



Puneet Talesera

Workspace Metal Solutions

2011
Formation

2012
Dedicated
Factory

175,000
Sq.Ft.
Manufacturing
Area

10+
International
Certifications

10+
MOT Solutions

200+
Customers
Served Globally

300+
Schools served

16,000
Kiosks

20,000
Server Racks

Contents

ARMOUR

8-9



XTRON

10-11



ECHO

12-13



DYNAMIC

14-15



XLAT

16-17



MODERN

18-19



XONNECT

20-21



XERA

22-23



FURNXT

24-25



INOX

26-27



ARMOUR



Technical Specifications (in mm)

Single Seater 600 W X 910 D X 750 H

Double Seater 1050 W X 910 D X 750 H

Three Seater 1500 W X 910 D X 750 H (With Intermediate Support)

WOOD SHADE

-  Bright Wooden Texture
-  Blue Suede
-  Light Wooden Texture

POWDER COATING

-  Color Variant Available



XTRON





Technical Specifications (in mm)

Single Seater 600 W X 910 D X 750 H

Double Seater 1050 W X 910 D X 750 H

Three Seater 1500 W X 910 D X 750 H (With Intermediate Support)

WOOD SHADE

-  Bright Wooden Texture
-  Blue Suede
-  Light Wooden Texture

POWDER COATING

-  Color Variant Available



ECHO





Technical Specifications (in mm)

Single Seater 600 W X 910 D X 750 H

Double Seater 1050 W X 910 D X 750 H

Three Seater 1500 W X 910 D X 750 H (With Intermediate Support)

WOOD SHADE

-  Bright Wooden Texture
-  Blue Suede
-  Light Wooden Texture

POWDER COATING

-  Color Variant Available



DYNAMIC



Technical Specifications (in mm)

Single Seater 600 W X 910 D X 750 H

Double Seater 1050 W X 910 D X 750 H

Three Seater 1500 W X 910 D X 750 H (With Intermediate Support)

WOOD SHADE

-  Bright Wooden Texture
-  Blue Suede
-  Light Wooden Texture

POWDER COATING

-  Color Variant Available



XLAT





Technical Specifications (in mm)

Single Seater 600 W X 910 D X 750 H

Double Seater 1050 W X 910 D X 750 H

Three Seater 1500 W X 910 D X 750 H (With Intermediate Support)

WOOD SHADE

-  Bright Wooden Texture
-  Blue Suede
-  Light Wooden Texture

POWDER COATING

-  Color Variant Available



MODERN





Technical Specifications (in mm)

Single Seater 600 W X 910 D X 750 H

Double Seater 1050 W X 910 D X 750 H

Three Seater 1500 W X 910 D X 750 H (With Intermediate Support)

WOOD SHADE

-  Bright Wooden Texture
-  Blue Suede
-  Light Wooden Texture

POWDER COATING

-  Color Variant Available



XONNECT



Technical Specifications (in mm)

Single Seater 600 W X 910 D X 750 H

Double Seater 1050 W X 910 D X 750 H

Three Seater 1500 W X 910 D X 750 H (With Intermediate Support)

WOOD SHADE

-  Bright Wooden Texture
-  Blue Suede
-  Light Wooden Texture

POWDER COATING

-  Color Variant Available



XERA



Technical Specifications (in mm)

Single Seater 600 W X 910 D X 750 H

Double Seater 1050 W X 910 D X 750 H

Three Seater 1500 W X 910 D X 750 H (With Intermediate Support)

WOOD SHADE

-  Bright Wooden Texture
-  Blue Suede
-  Light Wooden Texture

POWDER COATING

-  Color Variant Available



FURNXT



Technical Specifications (in mm)

Single Seater 600 W X 910 D X 750 H

Double Seater 1050 W X 910 D X 750 H

Three Seater 1500 W X 910 D X 750 H (With Intermediate Support)

WOOD SHADE

-  Bright Wooden Texture
-  Blue Suede
-  Light Wooden Texture

POWDER COATING

-  Color Variant Available



INOX





Technical Specifications (in mm)

Single Seater 600 W X 910 D X 750 H

Double Seater 1050 W X 910 D X 750 H

Three Seater 1500 W X 910 D X 750 H (With Intermediate Support)

WOOD SHADE

-  Bright Wooden Texture
-  Blue Suede
-  Light Wooden Texture

POWDER COATING

-  Color Variant Available



International Certificates



BIFMA X 5.5 : 2014 Certified Desking System focuses on development of Safety and Stringent performance standards for 24/7 application.



Desk Solution is tested against fire spread index, with lesser emission of smoke and flames to reduce the risk of hazardous accidents.



EPD certification is a mark of genuine "green" claim. This certification ensures that the user receives a credible green product from the supplier.



Metal structures is tested and certified for 1000 hours Salt Spray as per ASTM B117.



Life Cycle Assessment of our products are done for Cradle to Grave certification



Desk products are GREENGUARD GOLD certified for low chemical emission of VOCs (Volatile Organic Compounds) and carcinogens, contributing to a healthier room environment.



The product are tested by UL to nationally recognized Safety Standards and has been found to be free from reasonably foreseeable risk of fire, electric shock and related hazards in a Division 2 / Zone Environment.

Customized Design Solution

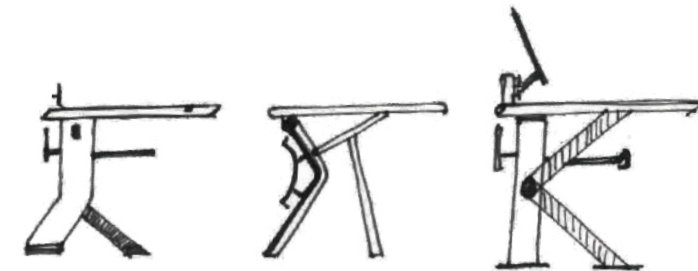
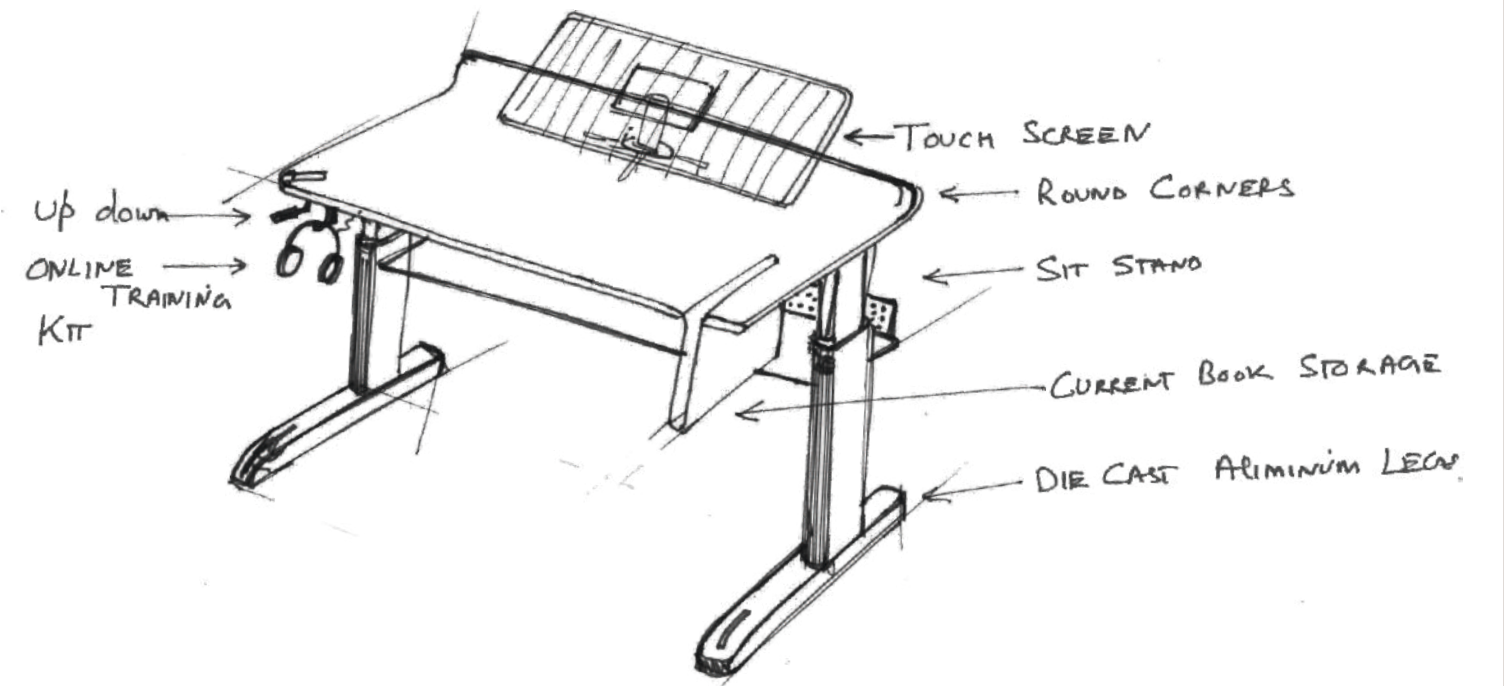

Project specific solutions can be designed for quantities > 5000 numbers.

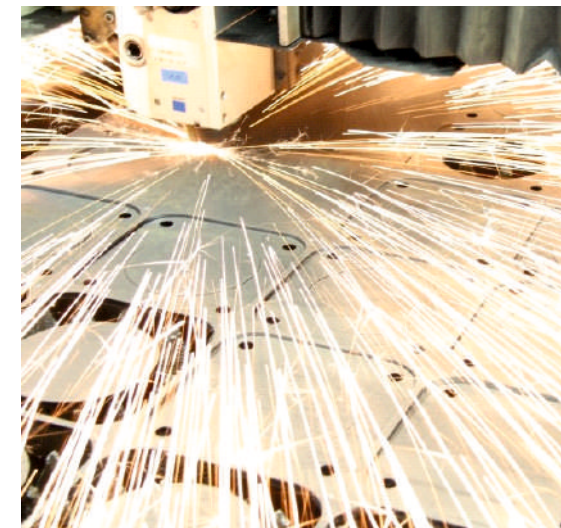
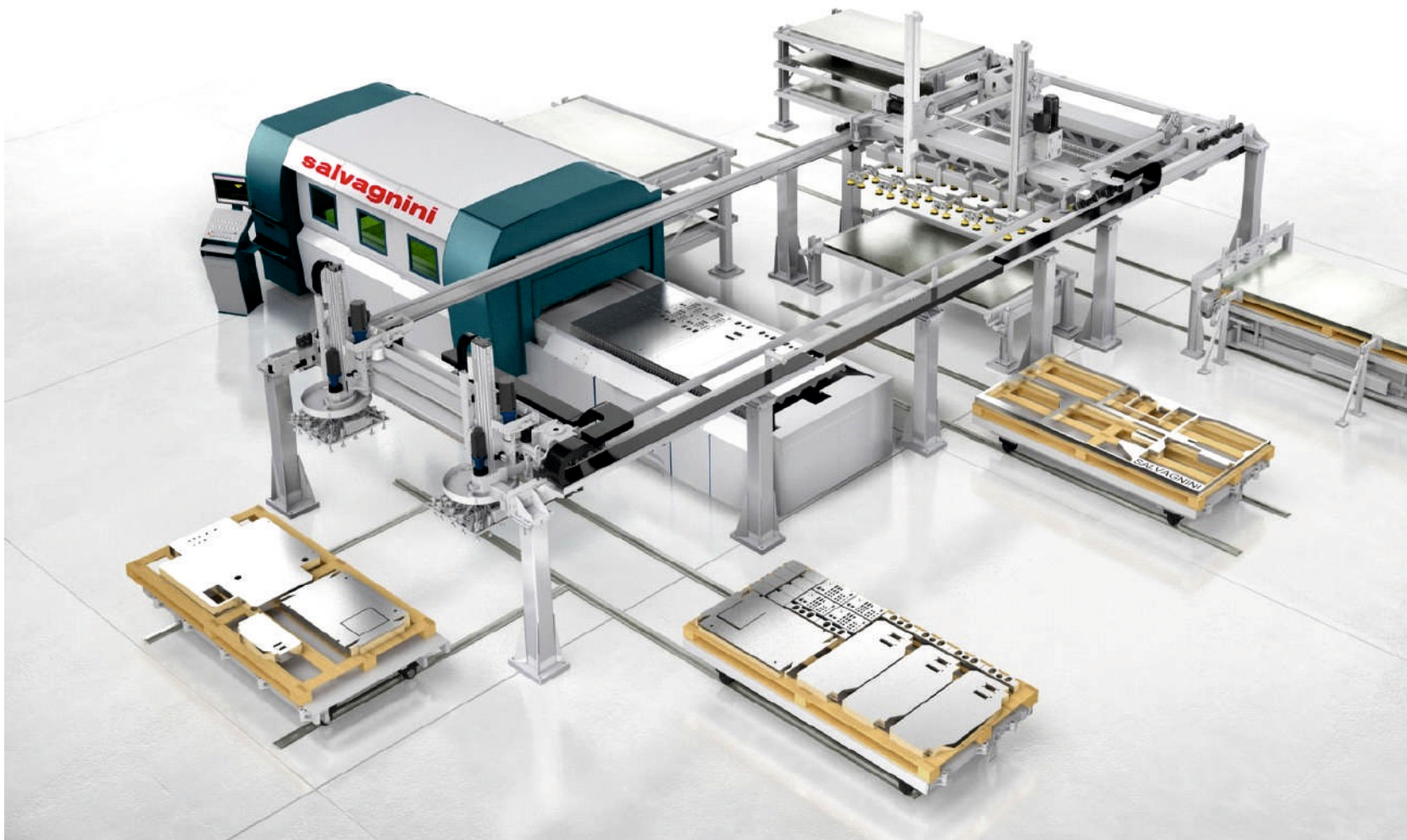

Best-in-Class Raw Material & Machinery

The raw material is procured from best-in-class brands like Wilsonart USA, Corian USA, Rehaus Germany, Weidmuller, AkzoNobel Dutch, and many more.

The raw materials are processed on pre-eminent machinery from Germany, Japan and Italy to offer highly optimized and customized solution.

100% In-house Manufacturing

Contact Us

Office

Pradeep Kaushik: +91 9870100938

Email: info@temflo.co.in



Marketed by :

Temflo System Pvt. Ltd.

12/19, Site-IV, Sahibabad Industrial Area,
Sahibabad-201010, Delhi-NCR.

Ph. 0120-4217441,

Website: www.temflo.co.in

E-mail: info@temflo.co.in



Designed & Manufactured by :

Workspace Metal Solutions Pvt. Ltd.

Plot No. B - 437, 438, Road No. 18A, Bhamashah
Industrial area, Kaladwas, Udaipur - 313002,
(Rajasthan)

Copyright 2022 Workspace Metal Solution Pvt. Ltd. All Rights Reserved.

This document is the intellectual property of Workspace Metal Solutions, Udaipur (Rajasthan). All the information contained in this brochure is true to the best of our knowledge. There might be color variations from the original work caused due to printing. Workspace Metal Solutions is the sole and exclusive owner of the copyrights as well as ancillary copyright. All use, and in particular any distribution, reprinting, exploitation or adaption of this document shall only be allowed with express, written approval by Workspace Metal Solutions.